

ALTERNATE B-B

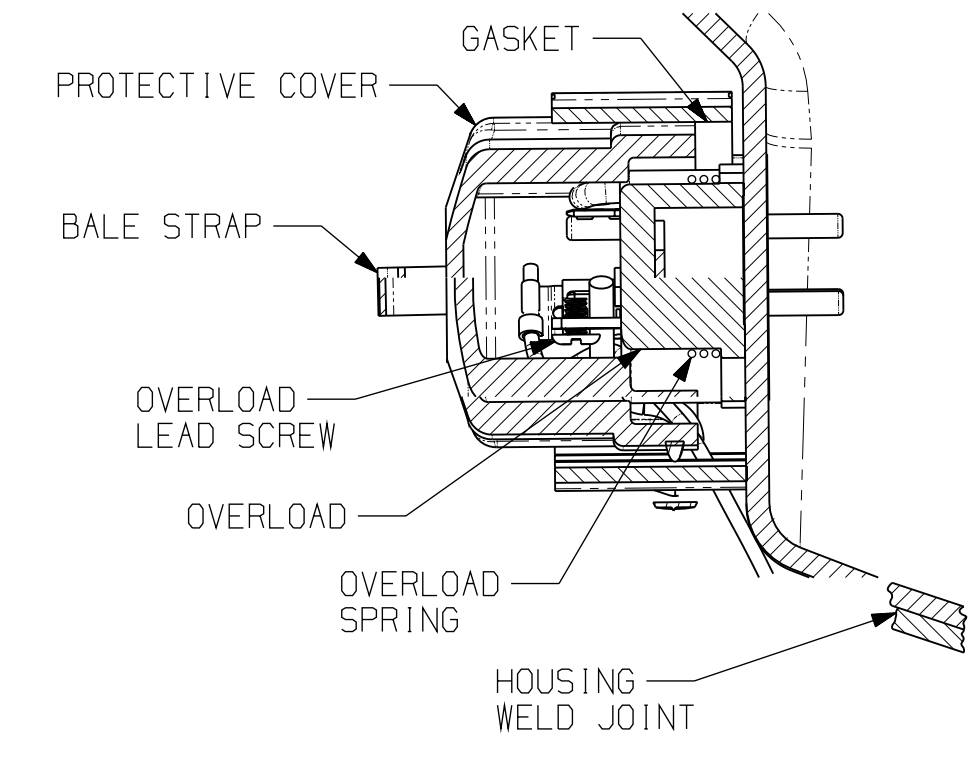

SECTION C-C

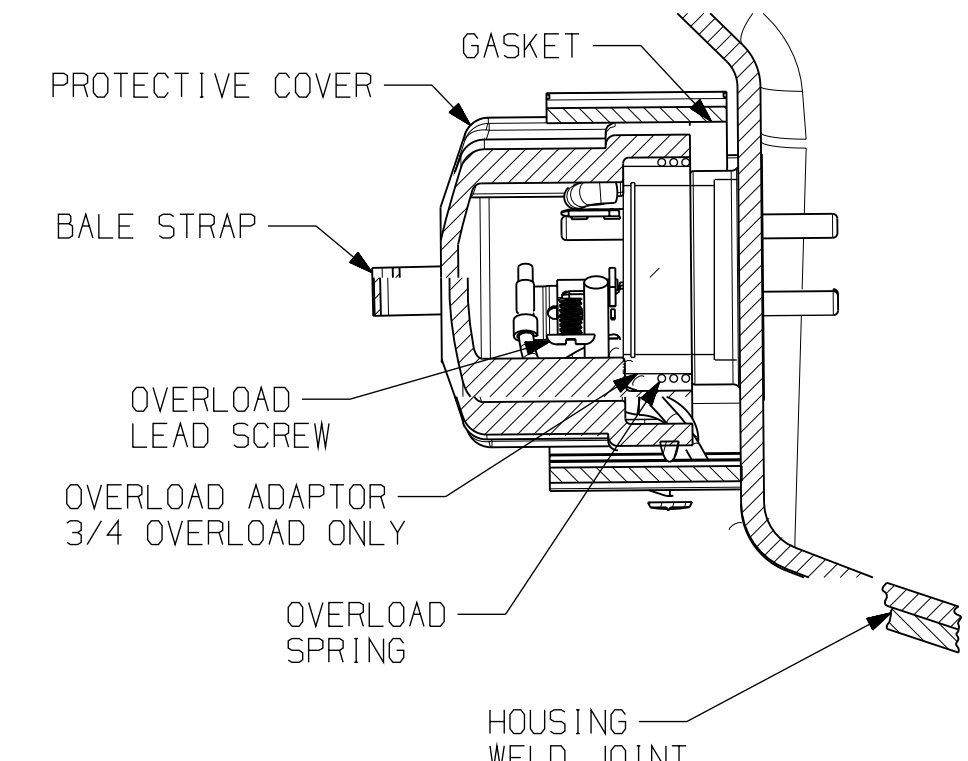

ALTERNATE C-C

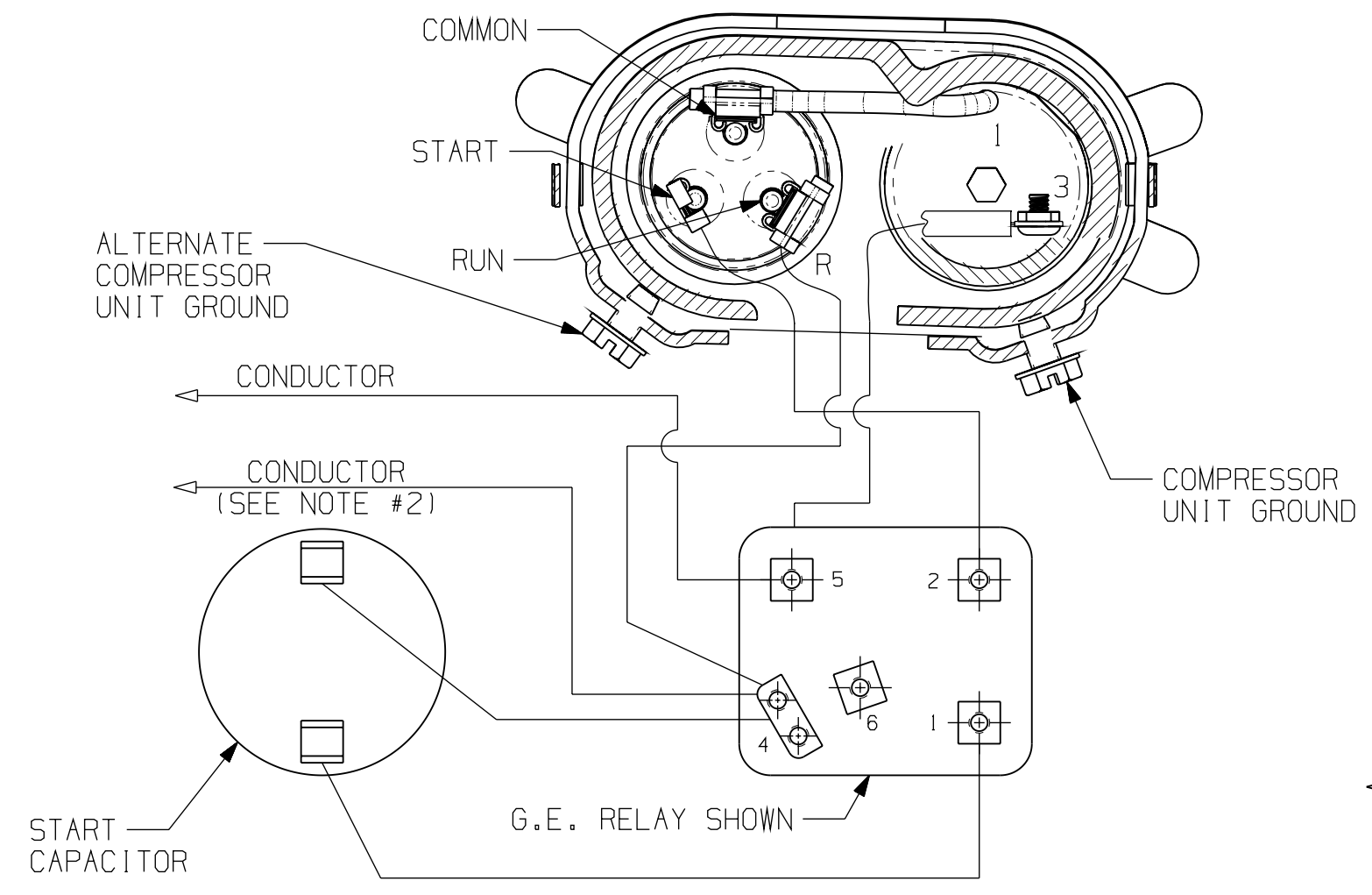

SECTION B-B

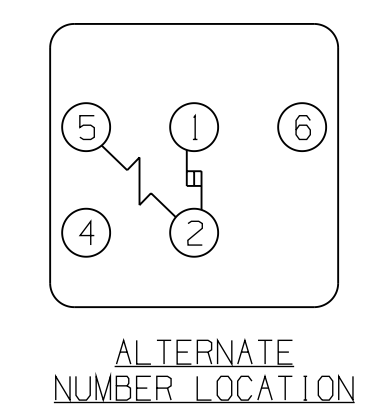
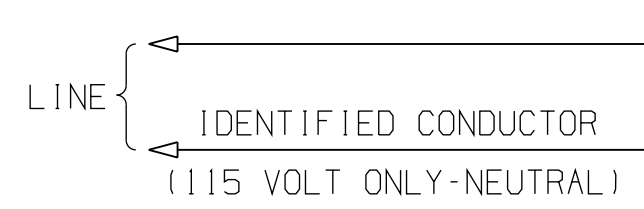
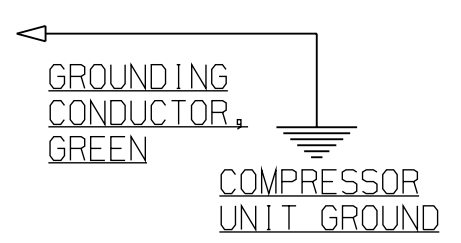

ALTERNATE NUMBER LOCATION

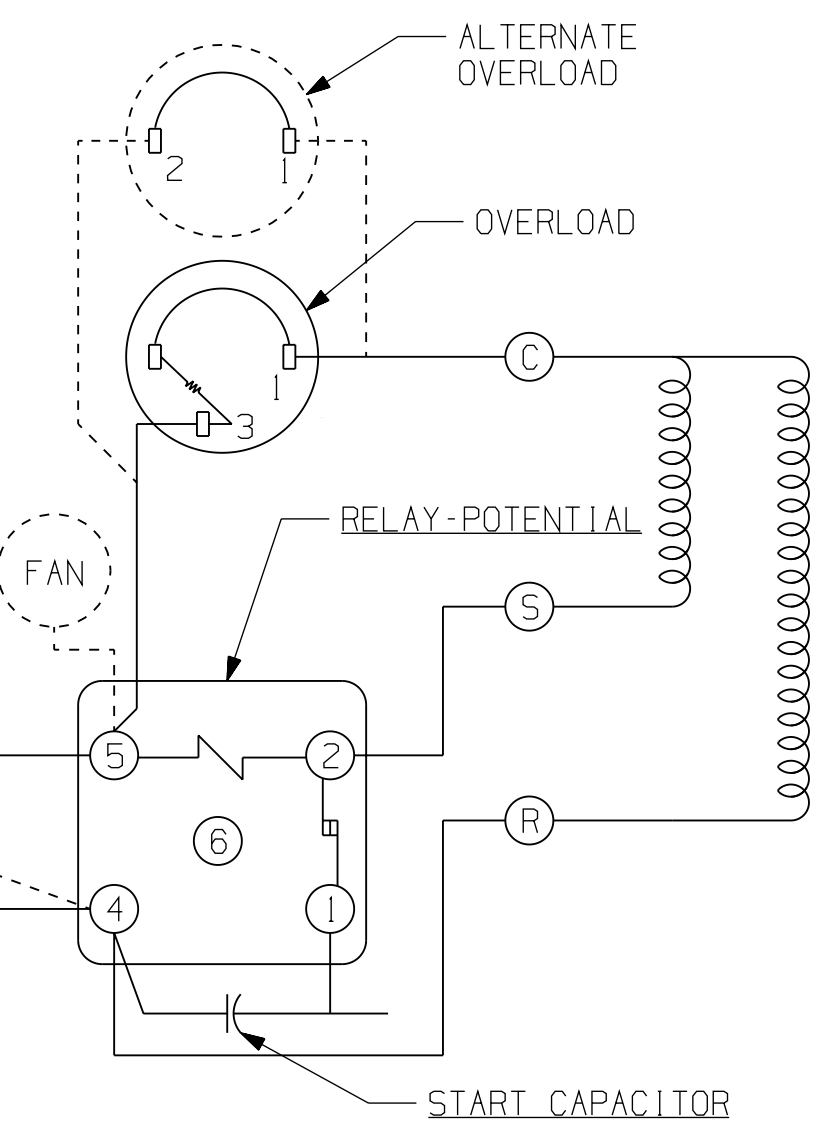

WARNING - WIRING DIAGRAM MUST BE FOLLOWED AS SHOWN. ANY MISWIRING CAN CAUSE SERIOUS ELECTRICAL HAZARD AND POTENTIAL DAMAGE OR RUPTURE OF COMPONENT ELECTRICAL PARTS.

NOTES:

1. ASSEMBLE THESE PARTS AS SHOWN IF SPECIFIED ON B/M.
2. IDENTIFIED CONDUCTOR MAYBE WHITE OR RIBBED (115 VOLT ONLY-NEUTRAL).
3. COMPRESSOR UNIT GROUND SCREW IS NOT PROVIDED BY T.C.CO.
4. MUST COMPLY WITH T.P.Co. GLOBAL SPEC 08.

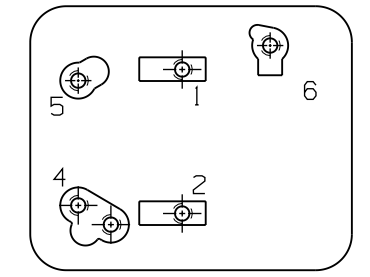

R.B.M.

ALTERNATE RELAY - HOOKUP DOES NOT CHANGE WHEN THESE RELAYS ARE USED.

115 OR 230 V.-SCHEMATIC WIRING DIAGRAM - CSIR - POTENTIAL RELAY (REF. DWG. MD472-10)

Ⓟ AJ - 115 OR 230 VOLT - CSIR - POTENTIAL RELAY

ENGLISH	
Q.A. SYMBOLS	
☆	= CATEGORY I
△	= CATEGORY II
□	= CATEGORY III
○	= CATEGORY IV

Banner User: ken.krzywdzinski Part/Rev: aj-deaj2_v-c.prt Date: 26-Jan-10 Time: 15:48

EC30306		KMK		DATE		DIS.CODE		NAME	
3A REVISED NOTE, 3C ADDED GLOBAL SPEC 08.		#244142-000 REDRAWN, & REVISED ORIENTATION OF LEAD WIRE.		-				ELECTRICAL HOOKUP	
V		U		LT LC		SCALE		THIS PRINT SUPERSEDES ALL PRINTS PRIOR TO	
						1:1 & NOTED		DRAWING NO.	
						MATERIAL		DEAJ2	
						DRAWING No. MDBBB-08		REVISION LEVEL: REL	
						NOTED			
						TECUMSEH PRODUCTS CO. TECUMSEH, MICHIGAN			